

CPP-2,CPA-2:

- If rollers in the rollerbase 07067 turn hard it is necessary to widen the holes in the rollerbase to a larger diameter. This sluggish movement of the rollers can be caused by expansion of the plastic from soaking in water. The friction caused by rollers turning hard can overburden the rotation motor. (Incorporated into production since Feb. 1983).
- Units built from May 1983 on have a heavier transformer for increased current output to the rotation motor. (CPA-2 AR 2260, GB 1010, 110V-unit 10030, CPP-2 AR 1155, GB 10057, 110V-unit 10078).
- In order to obtain VDE approval we modified the P.C. boards. (For detailed info: see specific section in service manual amendments.)
- The 'bearing' (center hole) in the pump housing for the pump impeller must be widened from 4,1mm to 4,5mm, to allow free rotation of the pump even when water is dirty. (This is incorporated in units since serial Nr.'s CPA-2 AR 2416, GB 10121; CPP-2 AR 1175, GB 10072).
- The red rotation trough has been changed underneath the rotation magnet to prevent water running over even when maximum water height is used. (Incorporated since serial Nr.'s CPA-2 2561, GB 10121; CPP-2 AR 1251, GB 10072).

Appendix to service file CPP-2

Transformer P.C. boards:

The transformer P.C. boards are all assembled according to the new layout (8216) known as the AT-1 design. This version does not incorporate the 100 Ohm 1/4 Watt resistor (40 018) which was soldered into the trace leading to the base of transistor tip 140/tip 3055. This resistor is now incorporated into a newly designed switch board (see next section for details). When using a combination of the new transformer board and the old switch board, it is necessary to ADD the Resistor as before (the same relates to all international design units).

Switching P.C. Board: (24025)

This newly designed switching board is totally compatible with the old version. For more information see the new schematic diagram (new boards have 8243 imprinted on solder side) (from serial Nr. 'S AR 1230, GB 10 072).

CPP-2 display P.C. board: (95068)

The display P.C. board has been redesigned utilizing stronger switches and incorporating a dimmer circuit for the LED displays. The new design is totally compatible with the old design and can be used interchangeably (the redesign is effective since 22.04.83 and starts with serial Nr. AR 1079, 10057, GB 10 120-USA).

In case service or replacement is necessary the following items should be checked and/or completed:

1. The three drilled holes for the temperature switches should be widened to 11 mm diameter.
2. The three numbered knobs which were previously used have to be replaced by one piece 07 114, and two pieces 07 115.
3. The display should no longer be 'floating' but should be firmly screwed on.
4. To improve reliability trimmer P41 should be changed from a dale part to an equivalent spectral part. The spectral part has been the cause of many problems.
5. The temperature sensor should be covered with a 'heat-shrink' tubing to protect from corrosion.

1.6 Serviceunterlagen CPP 2 4080
 Service information CPP 2 4080

- (A) Eichvorschrift Anzeigeplatine mit Temperaturfühler
 Instructions for final adjustment indicator P.C. board CPP 2
- (B) Montageanleitung " Kunststofftülle für Magnetventil"
 Mounting the PVC-hose for solenoid valve
- (C) Montageanleitung Pumpe, mit 2 Skizzen
 Mounting / dismounting pump
- (D) Motoreinstellung auf Schalterplatine
 Adjustment for motor
- (E) Fehlersuche
 Trouble shooting
- (F) Steckverbindungen der Platinen
 Connercters and socket
- (G) Trafoplatine: 1) Schaltplan 2) Bestückungsplan 3) Anschlußplan
 Transformer P.C. board: 1) circuit diagram 2) position of components
 3) position of connecters
- (H) Schalterplatine: 1) Schaltplan 2) Bestückungsplan 3) Anschlußplan
 Switch P.C. board: 1) circuit diagram 2) position of components
 3) position of connercters
- (I) Anzeigeplatine: 1) Schaltplan 2) Bestückungsplan
 Read out P.C. board: 1) circuit diagram 2) position of components
- (J) Datenblätter
 Data sheets
- (K) Ersatzteilliste
 Spare parts list
- (L) Explosionszeichnung
 Mechanica assembly

- (G) Trafoplatine : 4) Bauteile Liste
 Transformer P.C. Board: 4) components list
- (H) Schalterplatine: 4) Bauteile Liste
 switch P.C. Board: 4) components list
- (I) Anzeigeplatine : Bauteile Liste
 Read out P.C. Board : 4) components list

Montage des Pumpenläufers 95 081 CPP 2
Mounting the pump - shaft 95 081 CPP 2

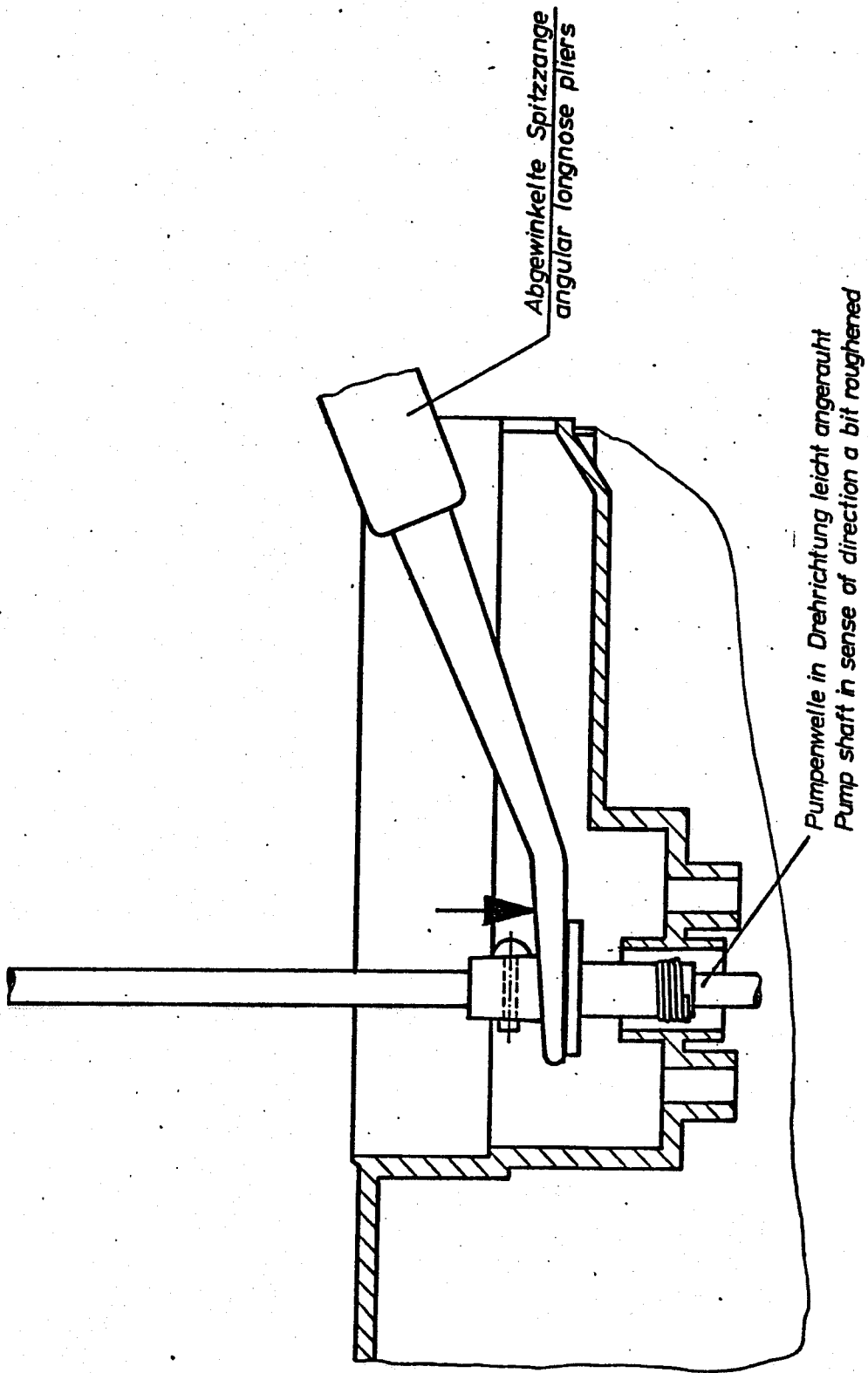

ab Nr. ST 11347
 GB 10435
 US 10533

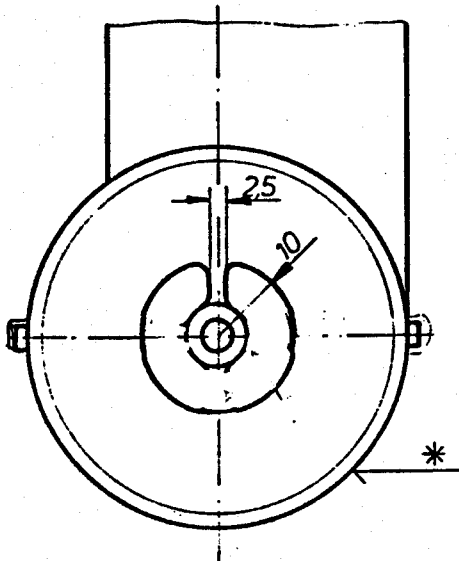

06 017

Pumpengehäuse

Pump housing

Blatt

Bl

An der unteren Führung im Pumpengehäuse wurden 3 der 4 Stege entfernt.
 Durch die jetzt mitschwingende Führung werden keine Geräusche mehr
 übertragen,

Three of the four sticks at the below guide inside the pump housing
 were deleted.
 Now no noises will be forwarded by the guide.

faulty operation	cause of fault - parts to be checked	
	transformer PC-board	switch PC-board
1.1 drive motor does not function	* -fuse 0,8 AT defect -R ₈ defect (high value) -D ₁ , D ₂ defect -T ₂ defect -shorted jumper	-C ₂₄ or C ₂₈ defect -R ₃₁ defect -D ₂₂ , D ₂₅ defect -IC ₂₂ defect - motor switch S ₂₃ defect
1.2 motor polarity does not reverse	-D ₂ , T ₂ defect	-micro switch defect -R ₂₂ , R ₂₃ defect -IC ₂₁ , IC ₂₂ defect
1.3 motor speed does not change	- C ₁ defect	-P ₂₁ improper adjustment -D ₂₁ , 22 or 25 wrong
1.4 max R.P.M. is reached at control knob position "P"		-P ₂₁ improper adjustment
1.5 motor speed is to slow		-T ₂₁ defect, improper unit
1.6 P ₂₁ , P ₂₂ do not respond		-trimmer defect -R ₂₈ wrong-C ₂₅ defect -cold solder joint
2.1 heater does not work	-reset over current device -R ₄ defect -IC ₁ defect, TIL 153 defect -T ₃ defect, GL ₁ defect - Triac MT ₁ defect 600 V	

* fuse 1,25 AT by Nr. 1155 (10 057 GB)



Trouble shooting CPP 2 / CPA 2

faulty operation	cause of fault - parts to be checked	
	transformer PC-board	switch PC-board
2.2 heats up to a certain temperatur only and at the wrong time	-C ₁ defect	-jumper defect
3.1 improper cooling or defect	-D ₃ wrong or defect -relay 12 001 defect -IC ₁ defect	-IC _{44,45,46} check for shorts
4.1 no read out		-read out defect -T _{41,43} defect -IC ₄₈ defect -IC ₅₀ defect
4.2 read out shows EEE		-temp.sensing device defect or disconnected -IC ₄₈ defect -IC ₄₉ defect
4.3 numbers missing at read out		-IC _{41,42,43,46 or 47} defect
4.4 read out shows 888 or part of it		-IC ₄₇ defect
4.5 middle segment of read out does not change		-C ₄₁ defect
4.6 read out does not change by adjusting P ₄₁		-trimmer defect -IC ₄₈ defect



Addition to Service manual of CPP-2/VDE-Version

The read out PC-board CPP-2 24026/8216 is different to the existing version by the new BCD-switches (same function) and an automatic change of the luminousness indication in dependence on the room light. This results changed impulse diagrams.

The 3 branches A-D, B-E, C-F are identical and are explained by use of A - D. Please observe that between identical signals of the branches exists a phase displacement.

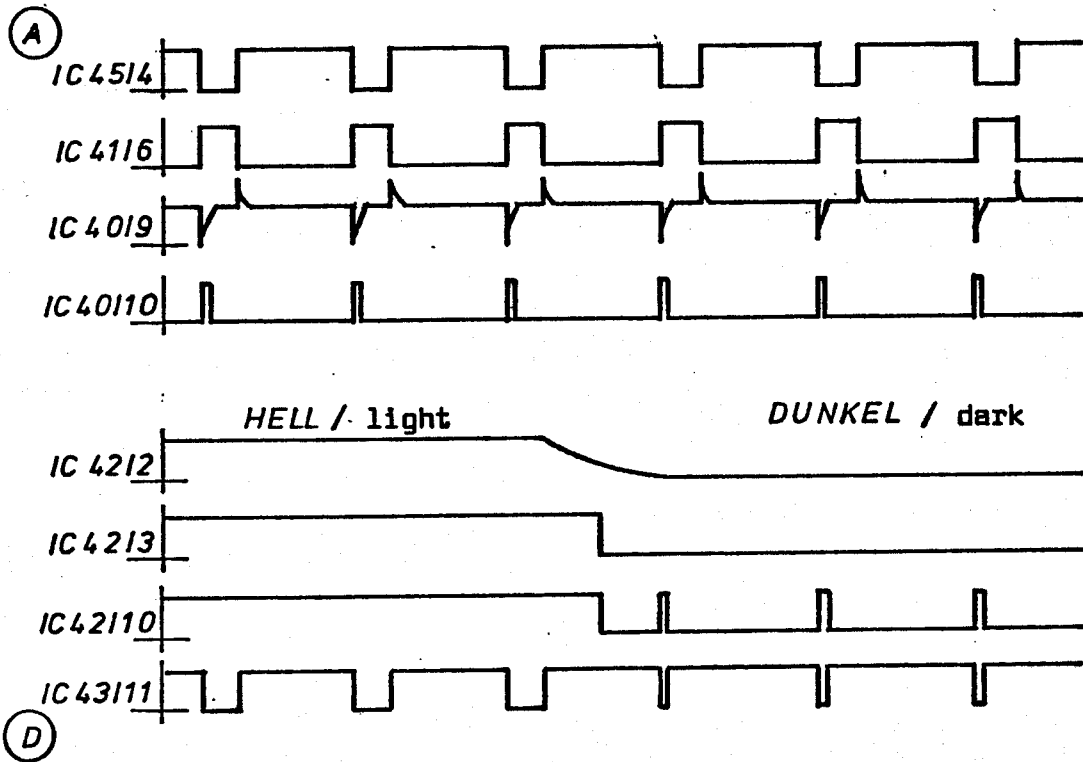

Instructions for final adjustment indicator P.C. board CPP 2

a) subject: power P.C.board and indicator P.C.board mounting, leads of temp.sensor soldered.
 (provide tension restainer a knot in a wire bad)

b) supple mentary equipment: 1) container with stirred water at ambiente temp.
 (ideal 19°C - 21°C, for temperatures outside that range see correction table ①)
 2) stirred water bath with constant temp.
 40,7°C ± 0,05
 3) power supply 5 V DC a piece of power cord
 a plug at one end and special connector for
 P.C. board at the other end.
 4) tool for potentiometer adjustments, nail polish
 (cosmetic)
 5) 2 thermometers for water temp. checks.

①	correction table bath 1 temp. others than 20 °C	bath temperatur °C	correction value °C
	17	- 18,9	+ 1/10
	19	- 21,5	-
	21,6	- 24	- 1/10

c) procedure:

- 1) connect P.C. board set amplification to center pos. (P 40)
- 2) put temp. sensor into water bath (20°C)
- 3) adjust pot. (P 41) to bath ① temp.
 (19 - 21°C or see correction table one)
- 4) put temp.sensor into bath ② (~~40,7°C~~) 38.3
- 5) adjust pot. (P 40) untill read out shows value according to correctionstable 2.
 after that adjust pot (P 41) untill read out shows 40 °C.
- 6) put temp.sensor into bath ① again, read out must show temp. used under paragraph 3 - 1/10
 if read out fails to show proper temp. repead procedures 3 to 6 again.
- 7) after adjustments have been completed secure pot. pos. with nail polish.

attention: gire temp. sensor allways enough time to adjust to bath temp.



Eichvorschrift CPP 2
 Instructions for final adjustment CPP 2

(A)

Korrektur - Tabelle
 corrections-table

angezeigter Wert if read out shows following value	einzustellender Wert adjust to this value	angezeigter Wert if read out shows following value	einzustellender Wert adjust to this value
36,5	44,2	40,0	40,0
36,6	44,1	40,1	39,9
36,7	44,0	40,2	39,8
36,8	43,8	40,3	39,7
36,9	43,7	40,4	39,6
37,0	43,5	40,5	39,5
37,1	43,4	40,6	39,4
37,2	43,3	40,7	39,3
37,3	43,1	40,8	39,2
37,4	43,0	40,9	39,1
37,5	42,9	41,0	39,0
37,6	42,7	41,1	39,0
37,7	42,6	41,2	38,9
37,8	42,5	41,3	38,8
37,9	42,3	41,4	38,7
38,0	42,2	41,5	38,6
38,1	42,1	41,6	38,5
38,2	42,0	41,7	38,4
38,3	41,9	41,8	38,3
38,4	41,7	41,9	38,3
38,5	41,6	42,0	38,2
38,6	41,5	42,1	38,1
38,7	41,4	42,2	38,0
38,8	41,3	42,3	37,9
38,9	41,2	42,4	37,9
39,0	41,1	42,5	37,8
39,1	40,9	42,6	37,7
39,2	40,8	42,7	37,6
39,3	40,7	42,8	37,5
39,4	40,6	42,9	37,5
39,5	40,5	43,0	37,4
39,6	40,4	43,1	37,3
39,7	40,3	43,2	37,2
39,8	40,2	43,3	37,2
39,9	40,1	43,4	37,1

27.8.84

Betr.: CPP 2 / CPA 2 - Pumpenmontage

Ab 27.7.84 wurden einige Verbesserungen bei der Pumpenmontage durchgeführt.

- 1) Montage der Pumpenwelle auf der Motorwelle ohne Vaseline
- 2) Aufrauen der Motorwelle mit Schmirgelleinen (Papier, Stärke 100) bei laufendem Pumpenmotor.

Ursache für die Änderung war, daß bei einigen Geräten die einwandfrei montierte Pumpenwelle, trotz festem Sitz, durch Vibrationen herunterrutschte und dadurch Geräusche erzeugte.

- 3) Der Führungsstift der Pumpenwelle muß zwischen 3 und 6 mm aus dem Pumpengehäuse ragen.

Re.: CPP 2/CPA-2 Pump mounting

From 27.07.1984 on we have made some improvements at the pump mounting:

- 1.) Mounting of the pump shaft on the motor shaft without Vaseline-grease.
- 2.) Rough up the motor shaft with abrasive cloth (paper, size 100) at running motor.

Reason for the change was that at some of the devices the correct mounted and fixed pump shaft jumped off by vibrations and produced noises.

- 3.) The guide pin of the pump shaft has to project over the pump housing for 3 - 6 mm.

pump CPA 2 / CPP 2

- 1) Dismantling :
- remove housing of pump
 - remove pump shaft with long nose pliers (angular pliers) (see picture number 1)
 - unscrew and remove pump motor

- 2) Assembling:
- position felt disc unto motor shaft and lubricate with resin free oil (Tellus 68)
 - * - Rough the motor shaft a bit in sense of direction (emery)
 - please extend the lower boring of the pump housing with a drill of 4,5 mm Ø .
 - attach pumpschaft with long nose pliers (see picture number 2) proper shaft position is importend
 - check pump shaft for wobble and readjust if needed.
 - attach pump housing, make sure it fits properly.

- attention:
- pump wheel must run free and not touch any part of the housing.
 - * - Min. distance between pump fan and the housing must be 3mm

technical data: motor V = 220 VAC (GB: V= 240 VCA; USA:V= 120 VCA)
P = 10 W

R.P.M. without load : = 2750 U /min. - 0,5 mm
over all lenght of pumpschaft : 222,5

special note:
concerning:

CPA 2 up to AD-No. 2597 (GB: AD 1200)
CPP 2 up to AD-No. 1724 (GB: AD 1070)

equipment with abore serial numbers has special pump motors.

In case of replacement use parts no. 95 059

to 240 V motor = 32 015 + 34 029
to 120 V motor = 32 008 + 34 029

special instructions: - new felt disc 18x4x1 mm for motor no. 95 099 /34 029

- new mounting screws: M4x18 Ms
replacement kit part no. 95 099
- resistor R 1 (560 Ohm) of transformer P.C. board must be passed-by
- replace pumpschaft with part no. 95 081

CPA 2 / CPP 2

Adjustments for motor (power p.c. board)

a) adjustments of servo-mechanism (P 21)

- 1) set motor speed control (P 23) to min. pos.
- 2) set trimmer P 21 to min.pos.
- 3) turn trimmer P 21 clockwise untill motor reaches max.speed
- 4) turn P 21 counter clockwise untill motor reaches min.speed
- 5) turn P 21 c.c.w. additional 15° .

b) adjustments of variable voltage control at P 22

- 1) set motor polarity-switching -arm to outside pos., adjust motor control (P 23) untill voltage at pin 6 (power transistor OP/base out put) of IC 22 reads 20 V.D.C. (approx.control knob pos "P")
- 2) set motor polarity-switching-arm to inside pos.
- 3) turn trimmer (P 22) c.c.w. to stop, zhan c.w. untill voltage reaches 5 to 7 V during polarity change of motor.

Instrument requirements :

oscilloscop or Analogvoltmeter
 change rate of voltage V / t : 15 V / sec.

Motor test data : motor (32 006) power supply 6 V.D.C. starting
 current max. 300 mA

Rotation rate : min. P 23 pos. = <25 R.P.M.
 max. P 23 pos. = >80 R.P.M-

b) variable voltage control must not be adjust

at Nr. AR 1230
 Nr. 10 072 GB
 Nr. 10 346 USA

Connecters and socket CPP2

Trafoplatine CPP 2 95 069	Schalterpl. CPA/CPP 2 95 071	Anzeigepl. CPP 2 95 068	Funktion / Anschluß
	N ₁		mains P
	N ₂		mains 0
M ₂	N ₃		mainswitch 0
	N ₄		mainswitch 0/NC
M ₁	N ₅		mainswitch P
M ₅	N ₆		heater-pump-switch P
	N ₇		heater-pump-switch
T ₁	S ₁		heater(0V-off/1,3V on delaytime on1,5s
T ₂	S ₂		cooling(0V-off/1,3Von)delaytimeon30 s
T ₃	S ₃		ground digital
T ₄	S ₄		+ 5 V
T ₅	S ₅		ground analog
T ₆	S ₆		24 - 32 V unregulated
T ₇	S ₇		out put OP/ base powertransistor
T ₈	S ₈		positive feedback +
T ₉	S ₉		ground
T ₁₀	S ₁₀		positive feedback -
T ₁₁	S ₁₁		relais reverse
	U ₁		} reverse mikro switch
	U ₂		
	U ₃		
	J ₁	J ₁	ground digital
	J ₂	J ₂	heater on/off
	J ₃	J ₃	cooling on/off
	J ₄	J ₄	+ 5 V
	J ₅	J ₅	ground analog
M ₃			} heater
M ₄			
M ₆			} pumpmotor
M ₇			
M ₈			} magnetic ventil
M ₉			
G ₁			rotation motor
G ₂			

15V / 0V
0V
0V / 15V

Bauteile - Liste / Component list

JOB0

Benennung : CPP 2 - Trafoplatine 94 009

Blatt 1
von 3 Blättern

Pos.	Stüchl.-Nr. Part No.	Bez. Ref.	Wert Value	Beschreibung Discription	Tol. % ±
1				Widerstände / Resistors	
2		R ₁			
3	40 123	R ₂	47 K		
4	40 123	R ₃	47 K		2 W 10
5	40 116	R ₄	22 K	alt. zu R2 u. R3	2 W 10
6	40 100	R ₅	4K7	CF 25	4 W 10
7	40 110	R ₆	10 K	CF 25	10
8	40 026	R ₇	270	CF 25	10
9	40 032	R ₈	1		10
10					2 W 10
11					
12					
13					
14					
				Kondensatoren / Capacitors	
15	41 012	C ₁	470 µ	AL-Elko	40 V
16	41 001	C ₂	10 µ	AL-Elko	
17	41 013	C ₃	100 µ	AL-Elko	16 V
18	41 013	C ₄	100 µ	AL-Elko	16 V
19	41 014	C ₅	220 µ	AL-Elko	10 V
20	41 001	C ₆	10 µ	AL-Elko	16 V
21	41 301	C ₇	10 n	Ker.	
22	41 011	C ₈	470 µ	AL-Elko	16 V
23	41 301	C ₉	10 n	Ker.	
24	41 301	C ₁₀	10 n	Ker.	
25	41 303	C ₁₁	100 n	Ker.	
26					
27					
28					
29					
30					

9	40 004 entfällt	8.3.83					
9	40 032 neu aufg.	8.3.83					
						Datum	Name
						Bearb	14.6.82 Px
						Gepr	7.7.82 Px
						Ers. f	
						Ers. d	
Pos	Anderung	Datum	Pos	Anderung	Datum		

Bauteile - Liste / Component list

JOB0

Benennung : CPP 2 - Trafoplatine

94 009

Blatt von 2
3 Blättern

Pos.	Stüchl.-Nr. Part No.	Bez. Ref.	Wert Value	Beschreibung Discription	Tol. % ±
1				Dioden / Diodes	
2	42 002	D ₁		1 N 4001	
3	42 001	D ₂		1 N 914	
4	42 001	D ₃		1 N 914	
5	42 001	D ₄		1 N 914	
6					
7					
8	42 301	Gl ₁		Gleichrichter / Rectifier B 40 C 800	
9	42 310	Gl ₂		B 40 C 1500	
10					
11					
12					
13					
14	44 011	T ₁		Transistoren/ Transistors .TIP 140	
15	44 009	T ₂		BC 337 - 40	
16	44 001	T ₃		BC 238 C	
17	44 004	T ₄		BC 517	
18					
19					
20					
21					
22					
23	45 004	IC ₁		Integrierte Schaltungen/Integrated Circuits CA 3079	
24	45 201	IC ₂		7805	
25					
26					
27					
28					
29					
30					

9	42301 entfällt	8.3.83					
9	42310 neu aufg.	8.3.83				Datum	Name
14	44005 entfällt	8.3.83			Bearb.	2.7.82	Px
14	44011 neu aufg.	8.3.83			Gepr.	7.7.82	Px
15	44001 in 44009	20.10.83			Ers. f.		
					Ers. d.		
Pos	Anderung	Datum	Pos	Anderung	Datum		

Bauteile - Liste / Component list

JOB0

(G)
4

Benennung : CPP 2 - Trafoplatine 94 009

Blatt 3
von 3 Blättern

Pos.	Stüchl.-Nr. Part No.	Bez. Ref.	Wert Value	Beschreibung Discription	Tol. % ±
1				Verschiedenes/ Miscellaneous	
2	44 101	TC ₁		Triac 600 V / 12 A	
3	44 041	KK ₁	6K/W	Kühlkörper/ Heat Sink	
4	44 041	KK ₂	6K/W	Kühlkörper/ Heat Sink	
5	25 036	T _{0-T} ₁₁		Stiftleiste 12-polig	
6	43 004	OK ₁		Optokoppler / Opto-Coupler	
7	21 008	RI ₁		Relais 12 V/1 S	
8	21 009	RI ₂		Relais 24 V/ 2 W	
9	48 026	TT ₁		Netztrafo / Mains Transformer	
10	27 017	FS ₁	T. 1,25 A	Sicherung / Fuse	
11	27 008	FS ₂	800mA	Sicherung / Fuse	
12	27 001	FH ₁		Sicherungshalter/ Fuseholder	
13	27 001	FH ₂		Sicherungshalter/ Fuseholder	
14	25 016	G ₁		Lötstift / Soldering Pin 4,8	
15	25 016	G ₂		Lötstift / Soldering Pin 4,8	
16	25 005	M _{1--M} ₉		Lötstift/Soldering Pin 6,3 (9St./pcs.)	
17					
18					
19					
20					
21					
22					
23					
24					
25					
26					
27					
28					
29					
30					

9	48015 entfällt	8.3.83					Datum	Name
9	48026 neu aufg.	8.3.83					Bearb.	2.7.82 Px
10	27008 entfällt	8.3.83					Gepr.	7.7.82 Px
10	27 017 neu aufg.	8.3.83					Ers. f	
							Ers. d	
Pos	Anderung	Datum	Pos	Anderung	Datum			

Auf Lötseite Fächerscheibe unterlegen!

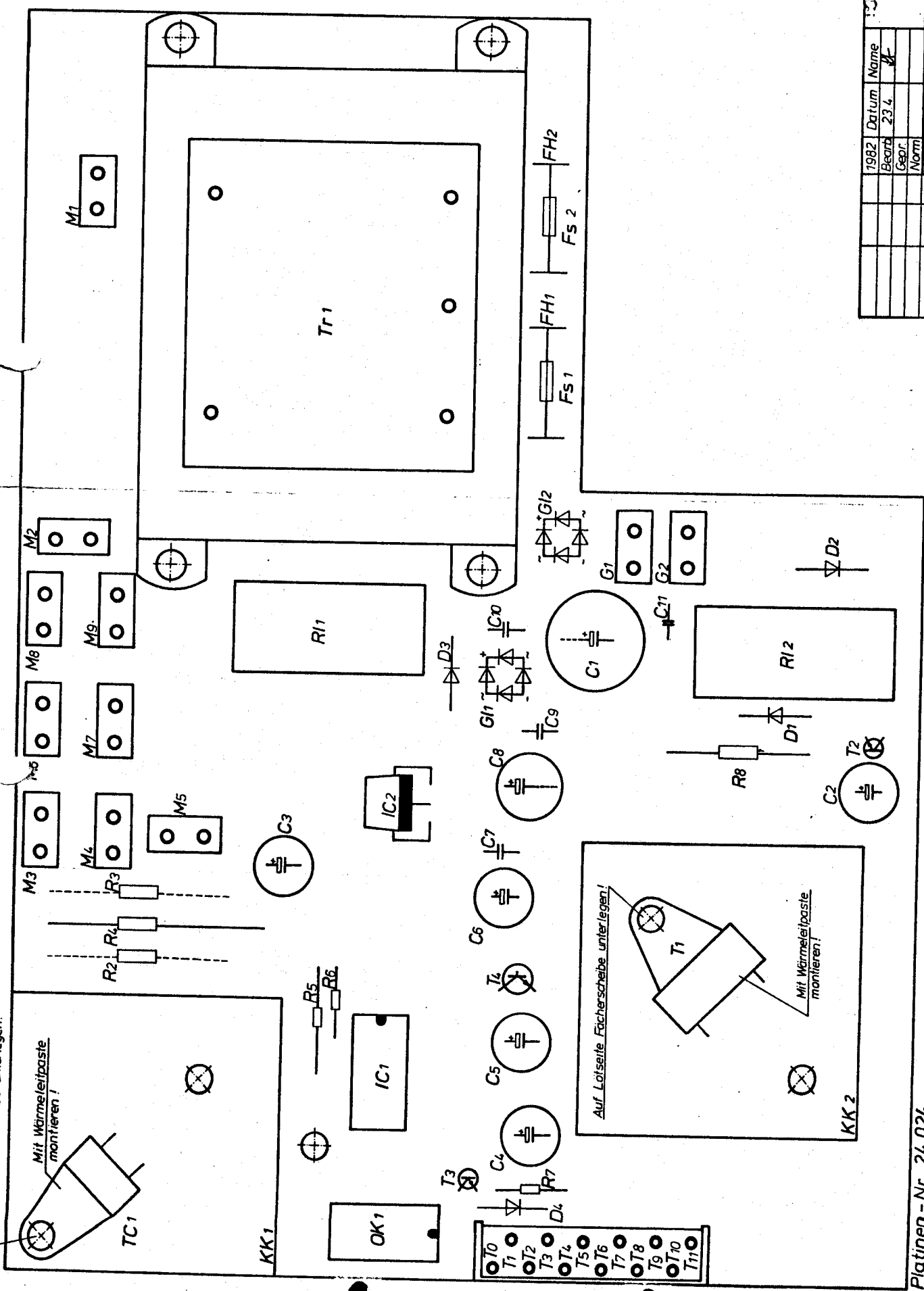

1982	Datum	Name
Beord.	23.4.	
Geor.		
Norm		

Bestückungsplan
Trafoplatine CPP 2

Anderung	Datum	Name
2	1.2.83	
1	22.7.82	

94.009

Platinen - Nr. 24.024
ab 8243

Mit Wärmeleitpaste montieren!

Auf Lötseite Fächerscheibe unterlegen!

Mit Wärmeleitpaste montieren!

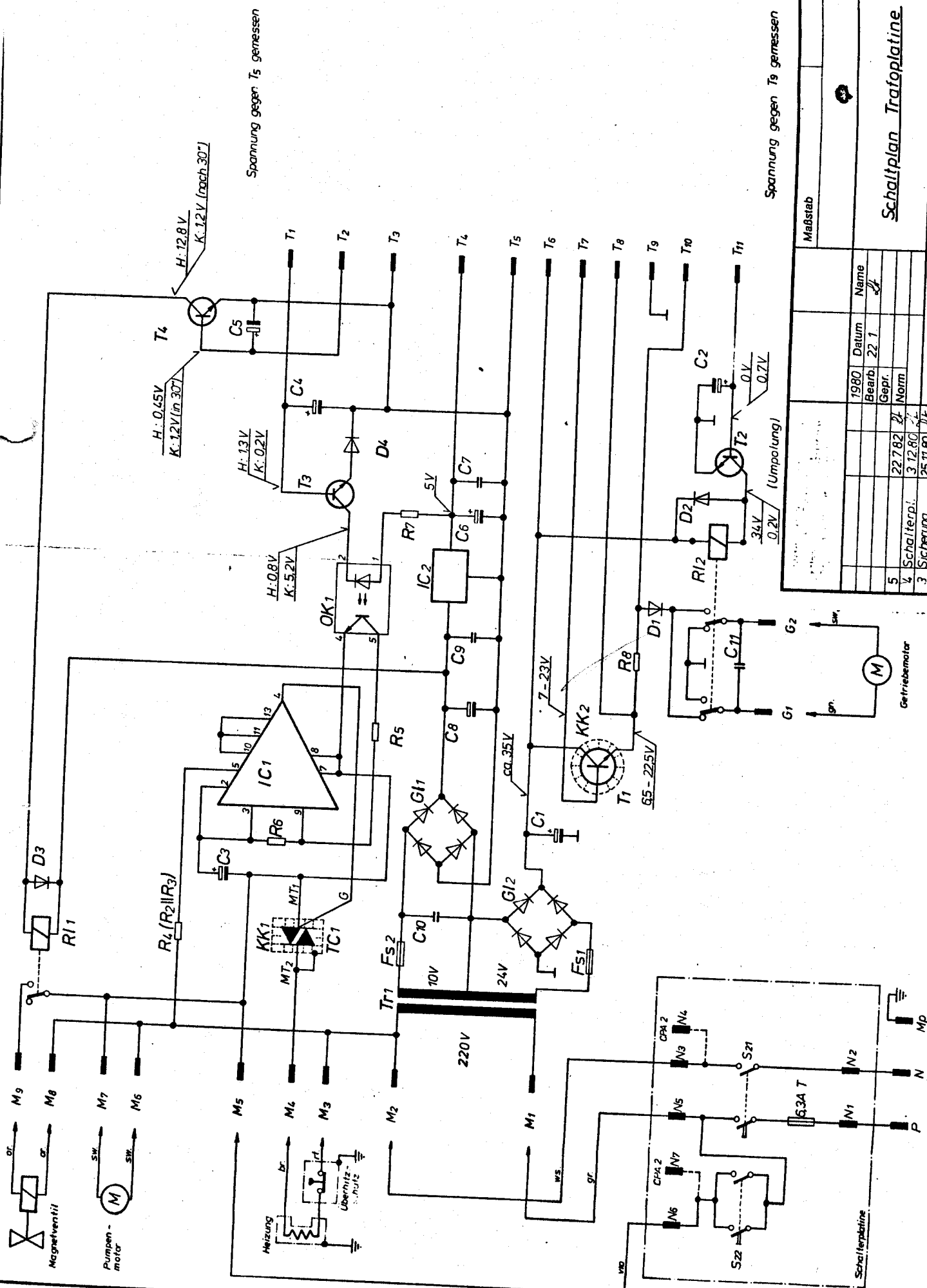

Spannung gegen T₅ gemessen

Spannung gegen T₉ gemessen

Maßstab		1980		Name	
		Datum			
		Bearb. 22.1.			
		Gepr.		Norm	
5		22.7.82		2	
4		3.12.80		2	
3		25.11.80		2	
2		R1 entfällt		25.11.80	
1		Änderung		21.4.80	
Zust.		Datum		Name (Urspr.)	
		24 024			
		Blatt		CPP 2	
		Bl.		Bl.	

Schaltplan Trafoplatte

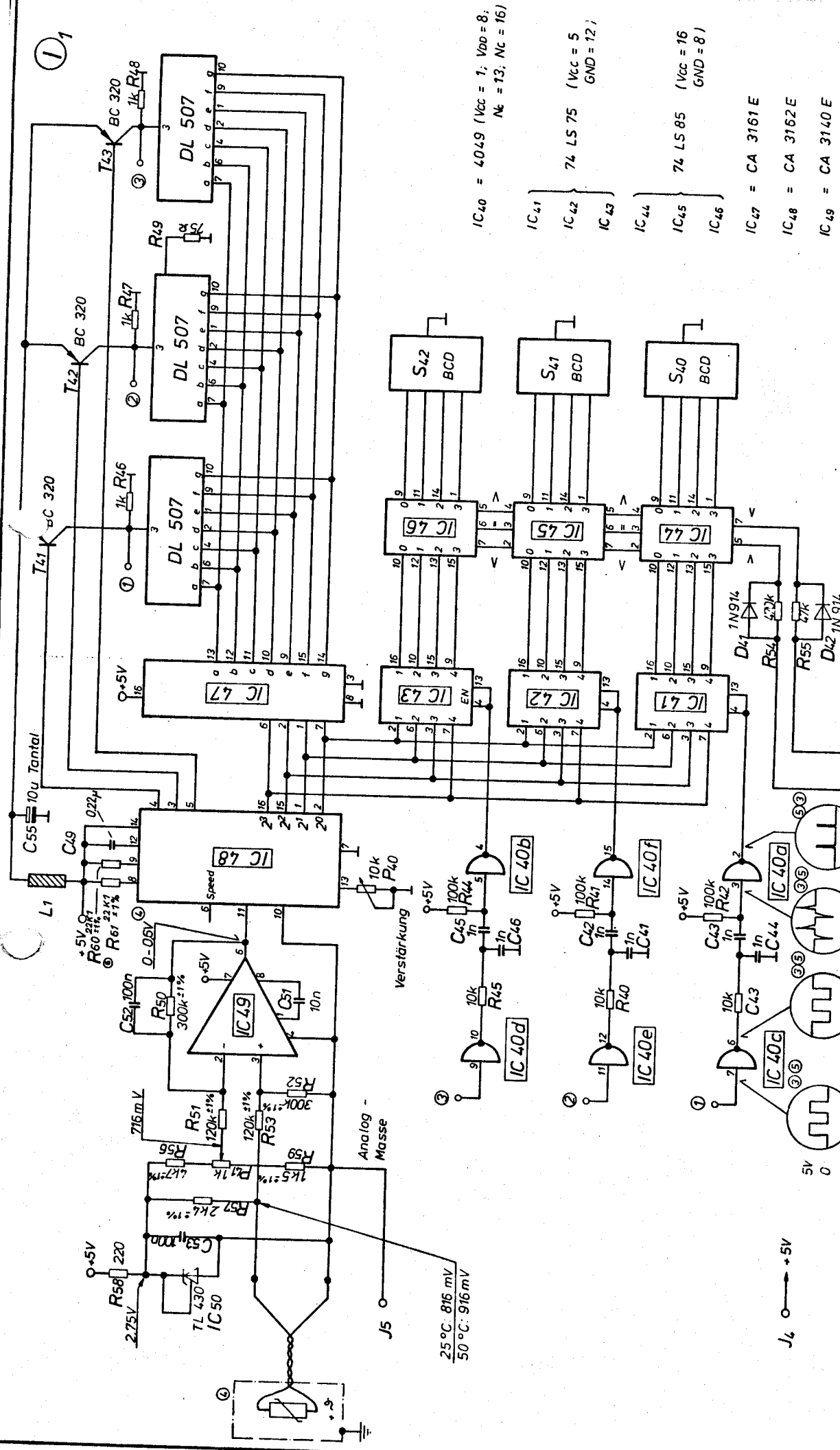

- IC₄₀ = 4049 (V_{cc} = 1; V_{DD} = 8; N_c = 13; N_c = 16)
- IC₄₁ } 74 LS 75 (V_{cc} = 5; GND = 12)
- IC₄₂ }
- IC₄₃ }
- IC₄₄ } 74 LS 85 (V_{cc} = 16; GND = 8)
- IC₄₅ }
- IC₄₆ }
- IC₄₇ = CA 3161 E
- IC₄₈ = CA 3162 E
- IC₄₉ = CA 3140 E

Maßstab

Schaltplan Anzeigeplatine

Blatt CPP 2

(Ers. d.)

1980		Name	
Bearb.	Datum		
6	R60 u. R61	27.02.77	Gepr.
5	Diagramme	18.2.87	Norm
4	Beschriftung	3.12.80	
3	Diagramme	3.12.80	
2	L1 und C55	31.7.80	
1	Zust.	21.4.83	

Änderung		Name (Urspr.)	
Zust.	Datum		



Gesamthöhe über Platine:
max. 14mm

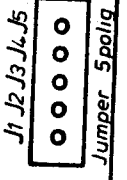
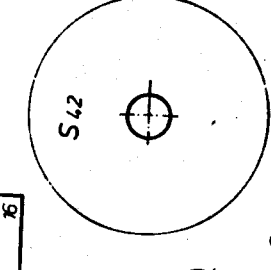
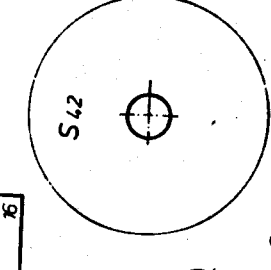
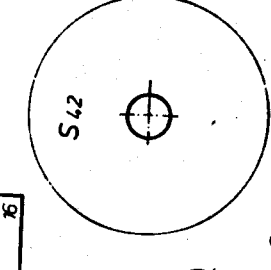
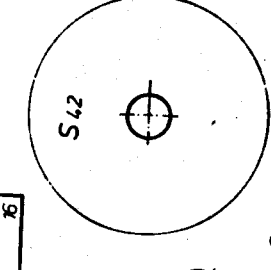
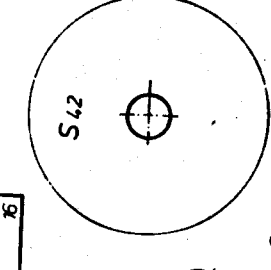
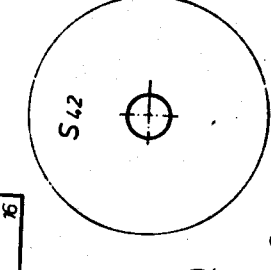
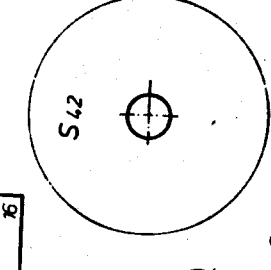
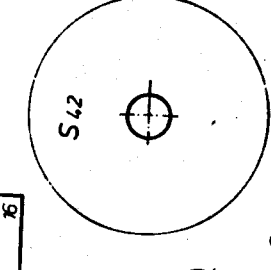
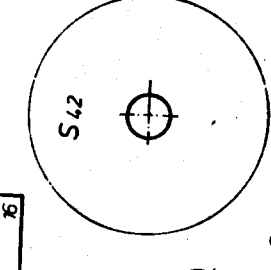
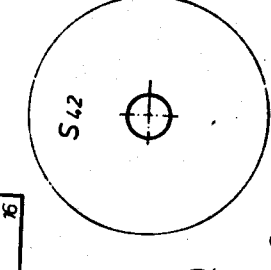
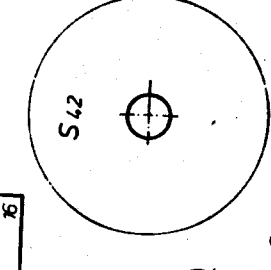
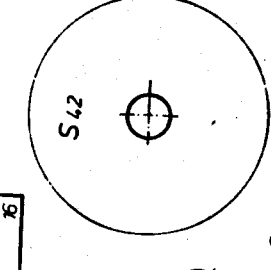
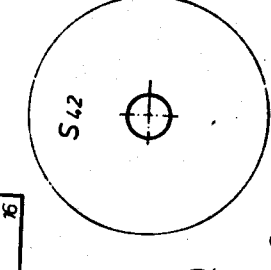
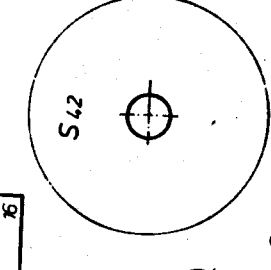
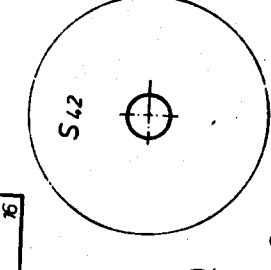
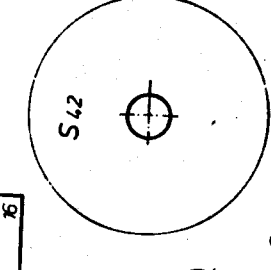
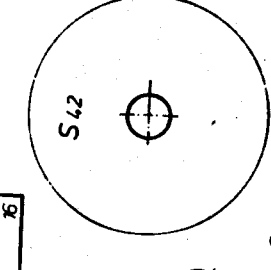
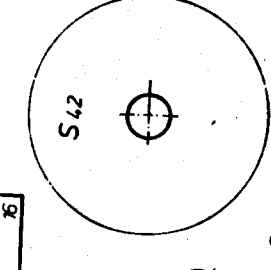
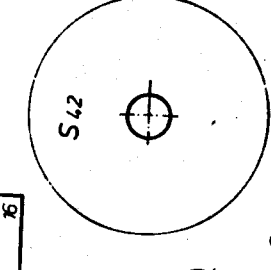
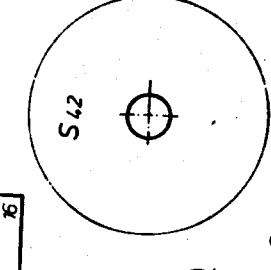
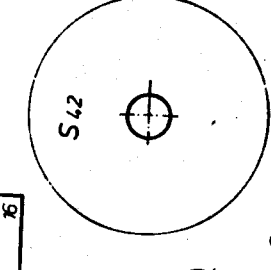
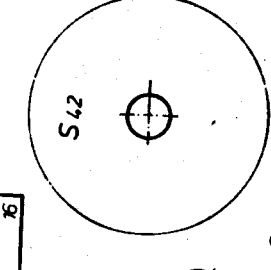
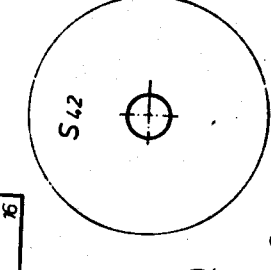
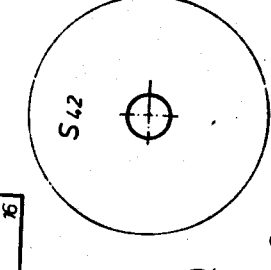
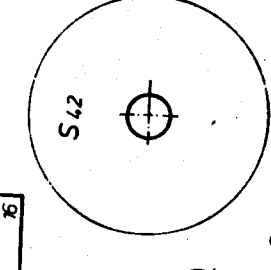
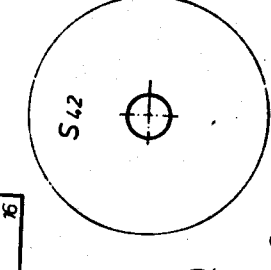
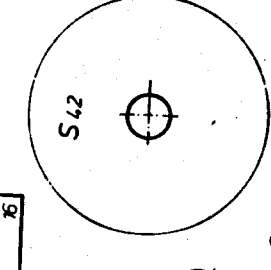
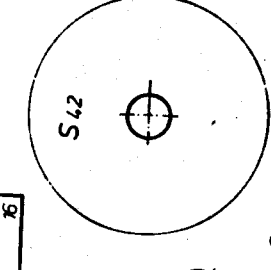
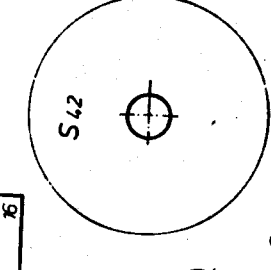
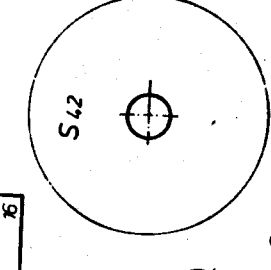
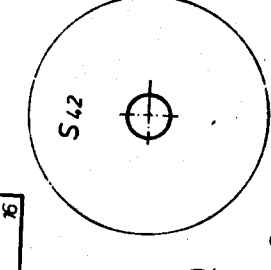
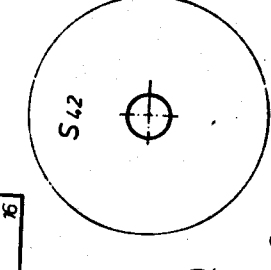
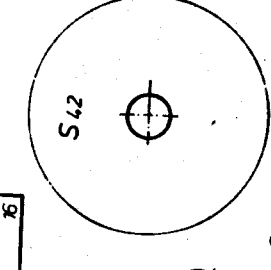
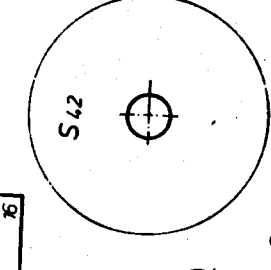
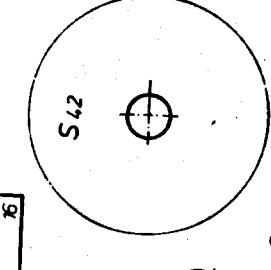
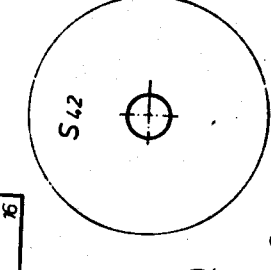
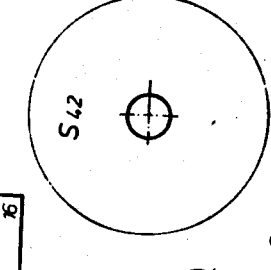
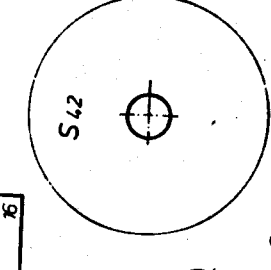
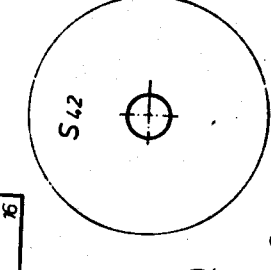
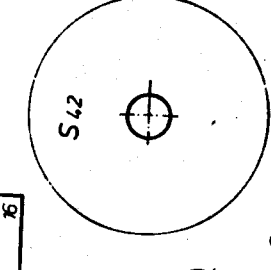
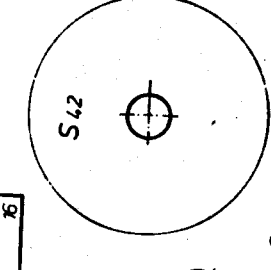
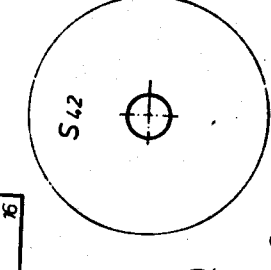
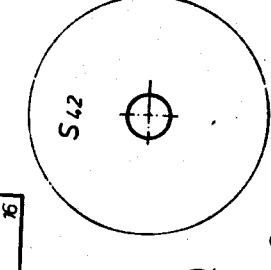
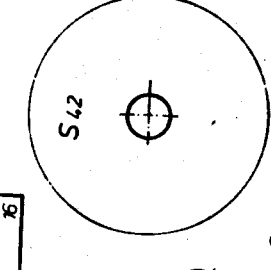
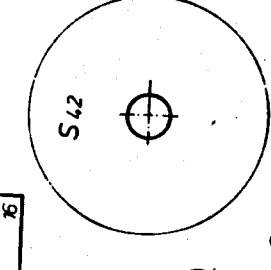
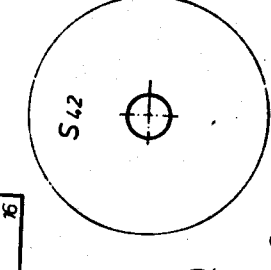
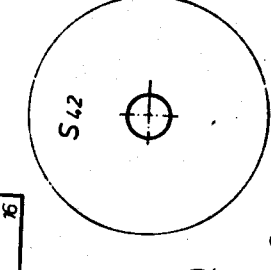
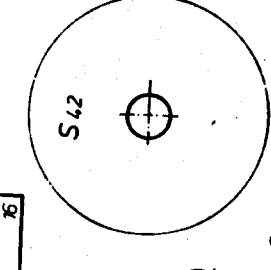
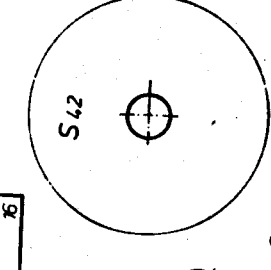
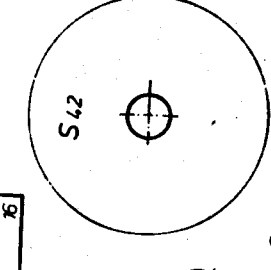
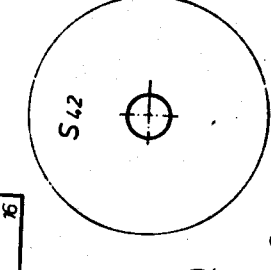
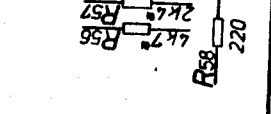
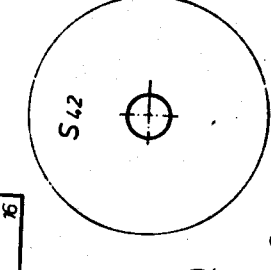
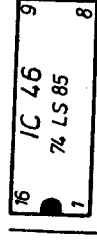
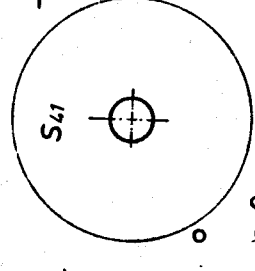
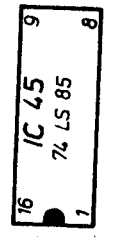
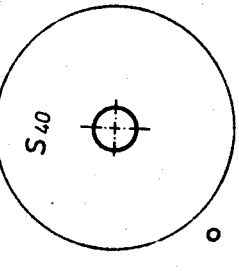
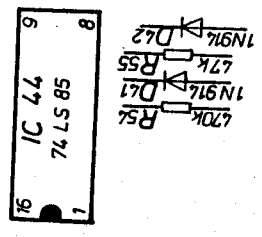
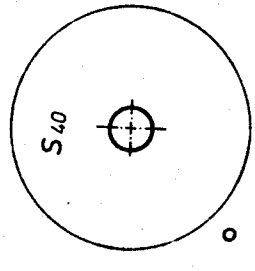
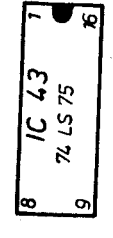
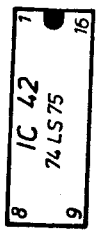
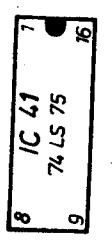
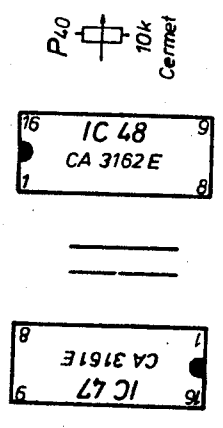
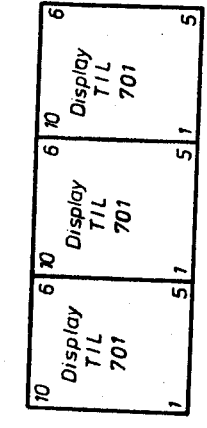
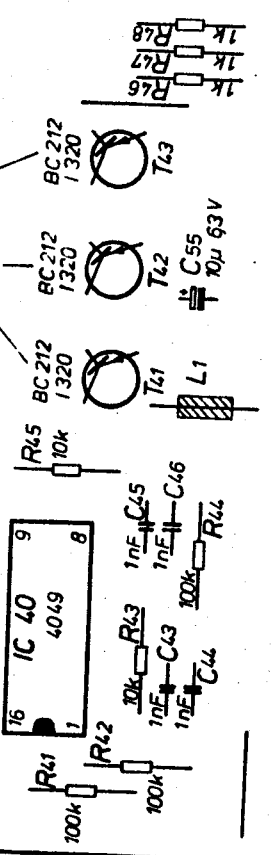

1980	Datum	Name
	Beard	21.4.
	Gepr.	
	Norm	

L1 und C55	31.7.80	Datum	Name
Anderung			

gültig bis 17.2.81 Geräte-Nr.: 2500 AD

Anzeigeplatine CPP 2

Bestückungsplan

24 026

Bauteile - Liste / Component list

JOB0

Benennung : CPP 2 - Anzeigeplatine 95 068

Blatt 1
von 4 Blättern

Pos.	Stüchl.-Nr. Part No.:	Bez. Ref.	Wert Value	Beschreibung Discription	Tol. % ±
1				Widerstände / Resistors	
2	40 128	R ₄₀	100 k	CF 25	
3	40 128	R ₄₁	100 k	CF 25	10
4	40 128	R ₄₂	100 k	CF 25	10
5	40 110	R ₄₃	10 k	CF 25	10
6	40 110	R ₄₄	10 k	CF 25	10
7	40 110	R ₄₅	10 k	CF 25	10
8	40 133	R ₄₆	270k	CF 25	10
9	40 115	R ₄₇	22 k	CF 25	10
10	40 083	R ₄₈	2k2	CF 25	10
11	40 083	R ₄₉	2k2	CF 25	10
12	40 083	R ₅₀	2k2	CF 25	10
13	43 003	R ₅₁	600/501x	LDR / RPY 58 A	
14	40 016	R ₅₂	75	CF 25	
15	40 128	R ₅₃	100 k	CF 25	10
16	40 128	R ₅₄	100 k	CF 25	10
17	40 128	R ₅₅	100 k	CF 25	10
18	40 315	R ₅₆	22k1	MF 25	10
19	40 315	R ₅₇	22k1	MF 25	1
20	40 320	R ₅₈	2M2	MF 25	1
21	40 319	R ₅₉	280 k	MF 25	2
22	40 305	R ₆₀	120 k	MF 25	1
23	40 319	R ₆₁	280 k	MF 25	1
24	40 305	R ₆₂	120 k	MF 25	1
25	40 023	R ₆₃	220	CF 25	1
26	40 304	R ₆₄	4k7	MF 25	10
27	40 303	R ₆₅	2k4	MF 25	1
28	40 302	R ₆₆	1k5	MF 25	1
29	40 136	R ₆₇	470 k	CF 25	1
30	40 124	R ₆₈	47 k	CF 25	10

10	40100 in 40083	17.2.85	21	40306 in 40319	29.5.85	Datum	Name
11	40100 in 40083	17.2.85	323	40306 in 40319	29.5.85	Bearb.	8.6.82 Px
12	40100 in 40083	17.2.85				Gepr.	11.6.82 Px
8	40128 in 40133	10.8.83				Ers. f.	
9	40110 in 40115	10.8.83				Ers. d.	
20	40318 neu aufg.	9.9.85					
21	40318 in 40320	29.5.85					
Pos	Anderung	Datum	Pos	Anderung	Datum	30. MAI 1985	

Bauteile - Liste / Component list

JOB0

Benennung : CPP 2 - Anzeigeplatine 95 068

Blatt 1
von 4 Blättern

Pos.	Stüchl.-Nr. Part No.	Bez. Ref.	Wert Value	Beschreibung Description	Tol. % ±
1				Widerstände / Resistors	
2	40 128	R ₄₀	100 k	CF 25	
3	40 128	R ₄₁	100 k	CF 25	10
4	40 128	R ₄₂	100 k	CF 25	10
5	40 110	R ₄₃	10 k	CF 25	10
6	40 110	R ₄₄	10 k	CF 25	10
7	40 110	R ₄₅	10 k	CF 25	10
8	40 133	R ₄₆	270k	CF 25	10
9	40 126	R ₄₇	75k	CF 25	10
10	40 083	R ₄₈	2k2	CF 25	10
11	40 083	R ₄₉	2k2	CF 25	10
12	40 083	R ₅₀	2k2	CF 25	10
13	43 006	R ₅₁		LDR	10
14	40 016	R ₅₂	75	CF 25	
15	40 128	R ₅₃	100 k	CF 25	10
16	40 128	R ₅₄	100 k	CF 25	10
17	40 128	R ₅₅	100 k	CF 25	10
18	40 315	R ₅₆	22k1	MF 25	10
19	40 315	R ₅₇	22k1	MF 25	1
20	40 321	R ₅₈	4M7	MF 25	1
21	40 319	R ₅₉	280 K	MF 25	2
22	40 305	R ₆₀	120 k	MF 25	1
23	40 319	R ₆₁	280 K	MF 25	1
24	40 305	R ₆₂	120 k	MF 25	1
25	40 023	R ₆₃	220	CF 25	1
26	40 304	R ₆₄	4k7	MF 25	10
27	40 303	R ₆₅	2k4	MF 25	1
28	40 302	R ₆₆	1k5	MF 25	1
29	40 136	R ₆₇	470 k	CF 25	1
30	40 124	R ₆₈	47 k	CF 25	10

Pos.	Änderung	Datum	Änderung	Datum	Name
10	40100 in 40083	17.2.81	21 40306 in 40319	29.5.85	Datum
11	40100 in 40083	17.2.81	323 40306 in 40319	29.5.85	Bearb
12	40100 in 40083	17.2.81	20 40320 in 40321	18.9.85	Sepr
8	40128 in 40133	10.8.83	39 40115 in 40126	30.4.85	rs f
9	40110 in 40115	10.8.83	13 43003 in 43006	30.4.85	rs d
9	40318 neu aufg.	9.9.81			
20	40318 in 40320	29.5.85			

Bauteile - Liste / Component list

JOB0

Benennung : CPP 2 - Anzeigeplatine 95 068

Blatt 1
von 4 Blättern

Pos.	Stüchl. - Nr. Part No.	Bez. Ref.	Wert Value	Beschreibung Discription	Tol. % ±
1				Widerstände / Resistors	
2	40 128	R ₄₀	100 k	CF 25	
3	40 128	R ₄₁	100 k	CF 25	10
4	40 128	R ₄₂	100 k	CF 25	10
5	40 110	R ₄₃	10 k	CF 25	10
6	40 110	R ₄₄	10 k	CF 25	10
7	40 110	R ₄₅	10 k	CF 25	10
8	40 133	R ₄₆	270k	CF 25	10
9	40 115	R ₄₇	22 k	CF 25	10
10	40 083	R ₄₈	2k2	CF 25	10
11	40 083	R ₄₉	2k2	CF 25	10
12	40 083	R ₅₀	2k2	CF 25	10
13	43 003	R ₅₁	600/501x	LDR / RPY 58 A	
14	40 016	R ₅₂	75	CF 25	
15	40 128	R ₅₃	100 k	CF 25	10
16	40 128	R ₅₄	100 k	CF 25	10
17	40 128	R ₅₅	100 k	CF 25	10
18	40 315	R ₅₆	22k1	MF 25	10
19	40 315	R ₅₇	22k1	MF 25	1
20	40 318	R ₅₈	1 M	MF 25	1
21	40 306	R ₅₉	300 k	MF 25	1
22	40 305	R ₆₀	120 k	MF 25	1
23	40 306	R ₆₁	300 k	MF 25	1
24	40 305	R ₆₂	120 k	MF 25	1
25	40 023	R ₆₃	220	CF 25	1
26	40 304	R ₆₄	4k7	MF 25	10
27	40 303	R ₆₅	2k4	MF 25	1
28	40 302	R ₆₆	1k5	MF 25	1
29	40 136	R ₆₇	470 k	CF 25	1
30	40 124	R ₆₈	47 k	CF 25	10

Pos.	Änderung	Datum	Pos.	Änderung	Datum	Datum	Name
10	40100 in 40083	17.2.83					
11	40100 in 40083	17.2.83				Bearb.	8.6.82 Px
12	40100 in 40083	17.2.83				Gepr.	11.6.82 Px
8	40128 in 40133	10.8.83				Ers. f.	
9	40110 in 40115	10.8.83				Ers. d	
20	40318 neu aufg.	9.9.83					

Bauteile - Liste / Component list

JOB0

Benennung : Schalterplatine CPP 2 95 114

Blatt 1
von 3 Blättern

Pos	Stüchl. - Nr Part No	Bez. Ref.	Wert Value	Beschreibung Discription	Tol % ±
1				Widerstände / Resistors	
2	40 018	R ₂₀	100	CF 25	
3	40 024	R ₂₁	220	CF 50	10
4	40 124	R ₂₂	47 k	CF 25	10
				0,5 W	
5	40 124	R ₂₃	47 k	CF 25	10
6	40 110	R ₂₄	10 k	CF 25	10
7	40 110	R ₂₅	10 k	CF 25	10
8	40 124	R ₂₆	47 k	CF 25	10
9	40 142	R ₂₇	1 M	CF 25	10
10	40 128	R ₂₈	100 k	CF 25	10
11	40 060	R ₂₉	1 k	CF 25	10
12	40 110	R ₃₀	10 k	CF 25	10
13	40 124	R ₃₁	47 k	CF 25	10
14	40 090	R ₃₂	3k9	CF 25	10
15	40 142	R ₃₃	1 M	CF 25	10
16	40 142	R ₃₄	1 M	CF 25	10
17	40 124	R ₃₅	47 k	CF 25	10
18	40 142	R ₃₆	1 M	CF 25	10
19	40 126	R ₃₇	75 k	CF 25	10
20					10
21				Potentiometer	
22	40420	P ₂₁	22 k	Kohle / Carbon	
23		P ₂₂			
24		P ₂₃	10 k	Teil von S ₂₃ / Part of S ₂₃	
25					
26					
27					
28					
29					
30					

geü. M. P.	22.11.83			Datum	Name
geü. H. P.	6.11.84			Bearb	11.6.82 Px/HB
				Gepr	30.6.82 Px
				Ers f	
				Ers c	
Prüfer	Dat.	Prüfung	Dat.		

Bauteile - Liste / Component list

JOB0

Benennung : Schalterplatine CPP 2 95 114

Blatt 2
von 3 Blättern

Pos.	Stüchl.-Nr. Part No.	Bez. Ref.	Wert Value	Beschreibung Discription	Tol. % ±
1				Kondensatoren/ Capacitors	
2		C ₂₀			
3	41 301	C ₂₁	10 n	Ker.	
4	41 301	C ₂₂	10 n	Ker.	
5		C ₂₃			
6	41 258	C ₂₄	0,22 µ	MKS	
7	41 258	C ₂₅	0,22 µ	MKS	
8	41 010	C ₂₆	100 µ	AL-Elko	40 V
9	41 301	C ₂₇	10 n	Ker.	
10	41 301	C ₂₈	10 n	Ker.	
11	41 020	C ₂₉	10 µ	AL-Elko	40 V
12	41 303	C ₃₀	100 n	Ker.	
13	41 303	C ₃₁	100 n	Ker.	
14	41 212	C ₃₂	0,1 µ	X / 250 V	
15					
16					
17					
18				Dioden / Diodes	
19	42 102	D ₂₁	5,6 V	Z-Diode	
20	42 108	D ₂₂	24 V	Z-Diode	
21	42 001	D ₂₃		1 N 914	1,3 W
22	42 001	D ₂₄		1 N 914	
23	42 107	D ₂₅	15 V	Z-Diode	
24	42 001	D ₂₆		1 N 914	
25	42 001	D ₂₇		1 N 914	
26	42 103	D ₂₈	6,8 V	Z-Diode	
27					
28	44 001	T ₂₁		Transistoren/ Transistors	
29	44 001	T ₂₂		BC 238 C	
30				BC 238 C	

26	42102 entfällt	7.7.82					
26	42103 neu aufg.	7.7.82					
						Datum	Name
						Bearb	11.6.82 Px/HB
						Gepr	30.6.82 Px
						Ers 1	
						Ers 2	
Pos.		Dat	hg	Änderung			

Bauteile - Liste / Component list

JOB0

Benennung : Schalterplatine -CPP 2 95 114

Blatt 3 von 3 Blättern

Pos.	Stüchl.-Nr. Part No.	Bez. Ref.	Wert Value	Beschreibung Discription	Tol. % ±
1				Integrierte Schaltungen/ Integrated Circuits	
2	46 111	IC 21		4001 B	
3	45 005	IC 22		CA 3140 E	
4					
5					
6					
7	20 027	S 21		Schalter/ Switches	
8	20 020	S 22		Drehschalter/ Rotary Switch	
9	20 019	S 23		Drehschalter/ Rotary Switch	
10				Drehsch.m.Poti/Rot.Switch with Pot.	
11					
12					
13					
14	25 037	S ₀ -S ₁₁		Verschiedenes/ Miscellaneous	
15				Stiftleiste 12 pol.	
16	27 005	FS ₁	F 6,3 A	Sicherung / Fuse	
17	27 001	FH ₁		Sicherungshalter / Fuseholder	
18	25 040	U ₁ -U ₃		Stiftleiste 3 pol.	
19	25 005	N ₁		Lötstift / Soldering PIN	
20	25 005	N ₂		Lötstift / Soldering PIN	
21	25 005	N ₃		Lötstift / Soldering PIN	
22					
23	25 005	N ₅		Lötstift / Soldering PIN	
24	25 005	N ₆		Lötstift / Soldering PIN	
25					
26	24 025			Schalterplatine CPP 2 ab 8243	
27					
28					
29					
30					

Pos.	Änderung	Datum	Pos.	Änderung	Datum	Datum	Name
						Bearb.	11.6.82 PX/HB
						Gepr.	1.7.82 Px
						Ers. f	
						Ers. d	

(H)

J1 J2 J3 J4 J5 S S1 S2 S3 S4 S5 S6 S7 S8 S9 S10 S11

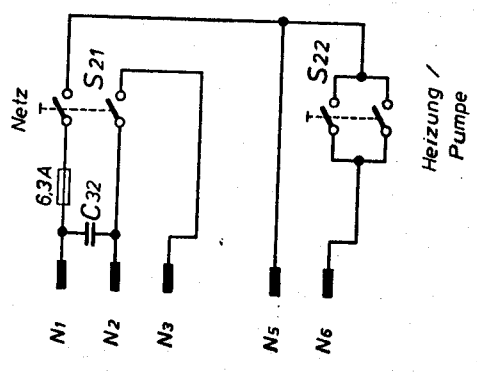
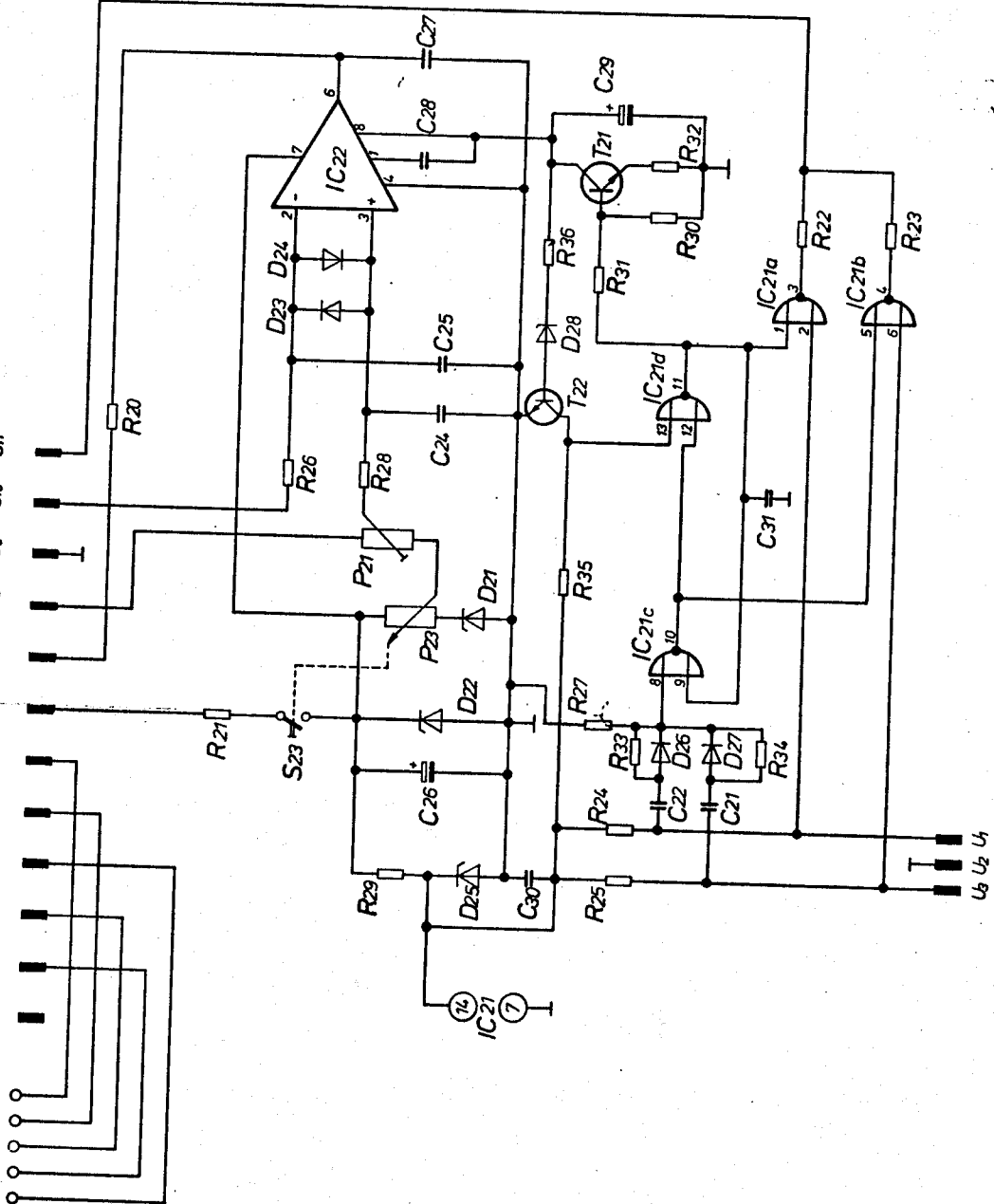

Platinen - Nr.: 24.025 / ab 8243

JOHANNES BOCKEMÜHL APPLIKATIONSBÜRO SIEGEN, G. B. R. M. 1980		Maßstab	
7	C32	1980	Name
6	20.4.83	Bearb.	21.1
5	15.6.82	Gepr.	
4	6.2.81	Norm	
3	3.12.80		
2	Anschluß R27		
1	R26: 100-47k		
Zust.	Änderung	Datum	Nr.
		21.4.80	95 114
			Blatt
			CPP2
			(Ers. L.)
			Bl.

Schaltplan Schalterplatine

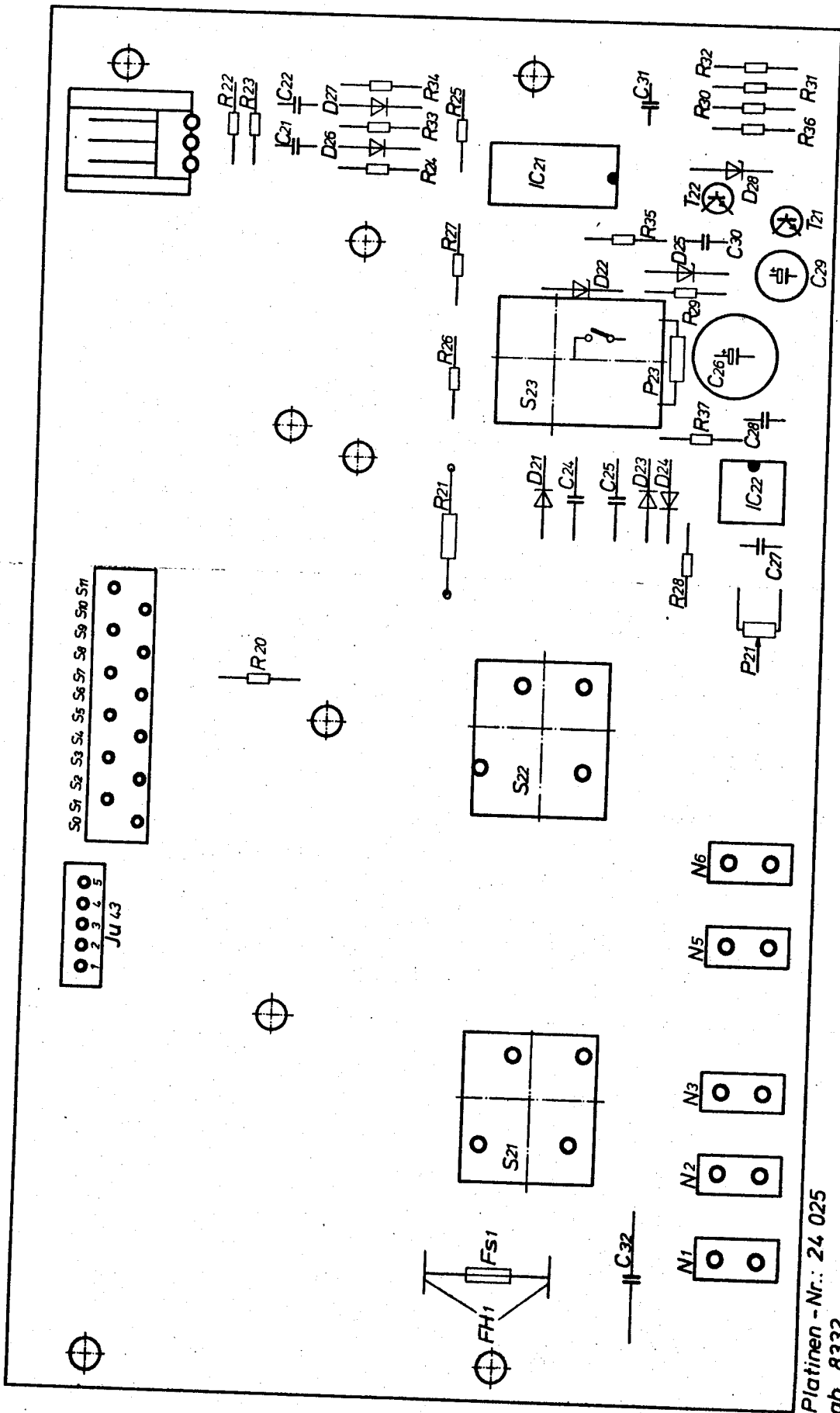

Platinen - Nr.: 24 025
ab 8332

1983	Datum	Name
	Bearb.	1.2
	Gepr.	1.2
	Norm	

Aenderung	Datum	Name
R37	16.12.83	

Bestückungsplan
Schalterplatine CPP 2

95 114